

PD683 & PD688

LOOP-POWERED METERS

Instruction Manual



PD688 only



Loop Leader[®]
Series

- 2 V drop (5.7 V with backlight)
- 5-Digit LCD, 0.6" (15.2 mm) High
- Custom Engineering Units
- 20-Segment Bargraph Display
- Type 4X, NEMA 4X, IP65 Front
- Maximum & Minimum Display
- Linear, Square Root, or Programmable Exponent
- Non-Volatile Memory – No Battery Needed

Loop-
Powered
Backlight
Standard!

PRECISION DIGITAL CORPORATION
89 October Hill Road • Holliston MA 01746 USA
Tel (800) 343-1001 • Fax (508) 655-8990

**PRECISION
DIGITAL**

www.predig.com

Disclaimer

The information contained in this document is subject to change without notice. Precision Digital makes no representations or warranties with respect to the contents hereof, and specifically disclaims any implied warranties of merchantability or fitness for a particular purpose.

Registered Trademarks

NORYL[®] and LEXAN[®] are registered trademarks of SABIC Innovative Plastics. All other trademarks mentioned in this document are the property of their respective owners.

© 2015 Precision Digital Corporation. All rights reserved.

Visit our Web Site
<http://www.predig.com>

INTRODUCTION

The PD688 is an intrinsically safe and non-incendive loop-powered meter approved for hazardous area locations. The PD683 is a general-purpose loop-powered meter for safe area applications. The four front panel buttons make the setup and programming an easy task. Five digits, bargraph, engineering units, and trend arrows provide a clear and attractive presentation of the process.

The square root and programmable exponent functions allow for conditioning of signals from non-linear transmitters without adding external components to the system and the convenience of scaling without a calibrated signal source make the PD683 & PD688 the ideal choice for process display applications.

ORDERING INFORMATION

Model	Description
PD683-0K0*	Loop-Powered Panel Meter for Safe Area
PD684-0K1	Loop-Powered Rate/Totalizer for Safe Area
PD688-0K0*	ATEX/FM/CSA Approved Loop-Powered Panel Meter
PD689-0K1	ATEX/FM/CSA Approved Loop-Powered Rate/Totalizer

Enclosures and Accessories

Model	Meters	Description	Mounting
PDA2407	1	Plastic NEMA 4X Enclosure	Inside Cover
PDA2410	3	Plastic NEMA 4X Enclosure	Inside Cover
PDA2411	2	Plastic NEMA 4X Enclosure	Inside Cover
PDA23XX	1-10	Economical Plastic NEMA 4X Enclosure	Through Door
PDA25XX	1-10	Plastic NEMA 4X Enclosure	Through Door
PDA26XX	1-6	Stainless Steel NEMA 4X Enclosure	Through Door
PDA27XX	1-6	Steel NEMA 4 Enclosure	Through Door
PDA2801*	1	Low-Cost Plastic NEMA 4X Enclosure	Through Cover
PDA2812	2	Low-Cost Plastic NEMA 4X Enclosure	Through Cover

Note: XX = the last two digits of the model number.

Go to www.predig.com to find individual part numbers.

* Quick Shipment Program product, typically shipped within 2 working days

Table of Contents

INTRODUCTION	3
ORDERING INFORMATION	3
SPECIFICATIONS	6
General	6
Input	7
PD688 COMPLIANCE INFORMATION	8
Ratings and Approvals	8
SAFETY INFORMATION	8
INSTALLATION	9
Unpacking	9
Panel Mounting	9
Wiring Connections	10
4-20 mA Input Connections	11
SETUP AND PROGRAMMING	12
Front Panel Buttons & Status Indicators	13
Main Menu Display Functions & Messages	14
Main Menu	15
Setting Numeric Values	15
Setting Up the Meter (SEtUP)	16
Setting the Decimal Point (dECPt)	16
Setting the Units Display (unItS)	17
Programming the Meter (PrOG)	18
Scaling the Meter (SCALe)	19
Calibrating the Meter (CAL)	20
Recalibrating the Internal Calibration Reference (iCAL)	20
Setting Up the Bargraph (GrAPH)	21
Setting Up the Password (PR55)	22
Locking the Meter	22
Unlocking the Meter	23
Advanced Features Menu	24
Advanced Features Menu & Display Messages	25
Math Functions (LnERr, SQURr, PRoGE, CUF)	26
Contrast (CONtR)	27
Noise Filter (FLtEr)	27
Noise Filter Bypass (bYP55)	27
Internal Calibration (iCAL)	28

PD683 & PD688 Loop-Powered Meters	Instruction Manual
Information Menu (<i>INF</i>)-----	29
OPERATION -----	30
Front Panel Buttons Operation -----	30
Maximum & Minimum Readings (<i>MAX</i> & <i>MIN</i>)-----	31
MOUNTING DIMENSIONS -----	32
Reset Meter to Factory Defaults -----	33
Factory Defaults & User Settings -----	34
TROUBLESHOOTING -----	35
Troubleshooting Tips -----	35
QUICK USER INTERFACE REFERENCE GUIDE -----	36

Table of Figures

Figure 1. Panel Cutout and Mounting.....	9
Figure 2. PD683 & PD688 Rear View.....	10
Figure 3. PD683 Input Connections with Backlight.....	11
Figure 4. PD683 Input Connections without Backlight.....	11
Figure 5. Meter Dimensions – Side View.....	32
Figure 6. Case Dimensions – Top View.....	32

SPECIFICATIONS

Except where noted all specifications apply to operation at +25°C.

General

DISPLAY	Five digits (-99999 to 99999)	0.60" (15.2 mm) high, 7-segment, automatic lead zero blanking.
	Four characters (Engineering Units)	0.25" (6.4 mm) high, 14 segment.
	Bargraph	20-segment, 0% to 100% indication.
	Trend arrows	Up and down trend indication.
	Backlight	Orange (intensity varies with signal)
DISPLAY UPDATE RATE	2.5/second	
OVERRANGE	Display flashes 99999	
UNDERRANGE	Display flashes -99999	
PROGRAMMING METHOD	Four front panel buttons	
NOISE FILTER	Programmable from 1 to 199	
RECALIBRATION	Recalibration is recommended at least every 12 months.	
MAX/MIN DISPLAY	Max/min readings reached by the process are stored until reset by the user or until power to the meter is turned off.	
PASSWORD	Programmable password restricts modification of programmed settings.	
NON-VOLATILE MEMORY	All programmed settings are stored in non-volatile memory for a minimum of ten years if power is lost.	
NORMAL MODE REJECTION	64 dB at 50/60 Hz	
ENVIRONMENTAL	Operating temperature range: -30 to 65°C (-40°C allowed)* Storage temperature range: -40 to 65°C Relative humidity: 0 to 90% non-condensing *Below -30°C, the LCD becomes less readable.	
CONNECTIONS	Removable screw terminals accept 12 to 22 AWG wire	
ENCLOSURE & MATERIALS	1/8 DIN, high impact plastic, UL 94V-0, color: gray NORYL® Polyphenylene Ether & Polystyrene blend (PPE PS) Resin LEXAN® Polycarbonate (PC) Film	

MOUNTING	1/8 DIN panel cutout required. Two panel mounting bracket assemblies provided
TIGHTENING TORQUE	Screw terminal connectors: 4.5 lb-in (0.5 Nm) Mounting screws: 8.0 lb-in max. (0.9 Nm)
OVERALL DIMENSIONS	4.68" x 2.45" x 3.79" (119 mm x 62 mm x 96 mm) (W x H x D)
WEIGHT	5.7 oz (162 g)
WARRANTY	3 years parts and labor
EXTENDED WARRANTY	1 or 2 years, refer to Price List for details

Input

ACCURACY	±0.03% of span ±1 count, square root and programmable exponent: 10-100% FS	
FUNCTION	Linear, square root, or programmable exponent	
LOW-FLOW CUTOFF	-99999 to 99999 (-99999 disables cutoff function)	
TEMPERATURE DRIFT	50 PPM/°C from -40 to 65°C ambient	
DECIMAL POINT	Up to four decimal places: <i>d.ddddd, dd.dddd, ddd.ddd, dddd.d, or ddddd</i>	
CALIBRATION RANGE	An <i>Error</i> message will appear if input 1 and input 2 signals are too close together.	
	Input Range	Minimum Span Input 1 & Input 2
	4-20 mA	0.40 mA
VOLTAGE DROP	Without Backlight	With Backlight
	2.0 V maximum	5.7 V maximum
EQUIVALENT RESISTANCE	100 Ω @ 20 mA	285 Ω @ 20 mA
INPUT OVERLOAD	Over current protection to 2 A max.	

PD688 COMPLIANCE INFORMATION

Ratings and Approvals

FM & CSA	<p>Certified as intrinsically safe with entity for use in: Class I, Div 1, 2, Groups ABCD Class II, Div 1, Groups EFG Class II, Div 2, Groups FG Class III, Div 1, 2 Class 1, Zone 0, Group IIC Non-incendive: Suitable for use in Class I, Div 2, Groups ABCD; Class II, Div 2, Groups FG; Class III, Div 2. Entity Parameters: Ui: 30 V; Ii: 175 mA; Ci: 0; Li: 0; Pi: 1.0 W</p>
ATEX	<p> II 1G Ex ia IIC T4 IP65 Ta = -40°C to 65°C</p>
CE	<p>EMC Emissions and Immunity: EN 61326:2006 EMC requirements for Electrical equipment for measurement and laboratory use – Industrial IEC 61010-1:2010 & EN 61010-1:2010, including Group and National Differences as they apply for AU, CA, US and KR</p>

Special Conditions for Safe Use:

The permitted ambient temperature range for the PD688 is -40°C to 65°C.

Year of Construction

This information is contained within the serial number with the first four digits representing the year and month in the YYMM format.

For FM/CSA applications: The PD688 installation must be performed in accordance with Control Drawing **LIM688-2**

For European Community: The PD688 must be installed in accordance with the ATEX directive 94/9/EC, the product certificate FM08ATEX0058X, and **LIM688-2**

SAFETY INFORMATION



CAUTION: Read complete instructions prior to installation and operation of the meter.

Installation and service should be performed only by trained service personnel. Service requiring replacement of internal components must be performed at the factory.

INSTALLATION

There is no need to remove the meter from its case to complete the installation, wiring, and setup of the meter.

Unpacking

Remove the meter from box. Inspect the packaging and contents for damage. Report damages, if any, to the carrier.

If any part is missing or the meter malfunctions, please contact your supplier or the factory for assistance.

Panel Mounting

- Prepare a standard 1/8 DIN panel cutout – 3.622" x 1.772" (92 mm x 45 mm). Refer to *Mounting Dimensions*, page 32 for more details.
- Clearance: allow at least 4" (102 mm) behind the panel for wiring.
- Panel thickness: 0.04" - 0.25" (1.0 mm - 6.4 mm).
Minimum steel/stainless steel panel thickness to maintain watertight rating: 0.06" (1.5 mm).

Note: A steel or stainless steel panel rather than plastic is recommended in cases where a watertight or dust-tight seal is required between the meter and the panel.

- Remove the two mounting brackets provided with the meter (back-off the two screws so that there is ¼" (6.4 mm) or less through the bracket. Slide the bracket toward the front of the case and remove).
- Insert meter into the panel cutout.
- Install mounting brackets and tighten the screws against the panel. To achieve a proper seal, tighten the mounting bracket screws evenly until meter is snug to the panel along its short side. DO NOT OVER TIGHTEN, as the rear of the panel may be damaged.

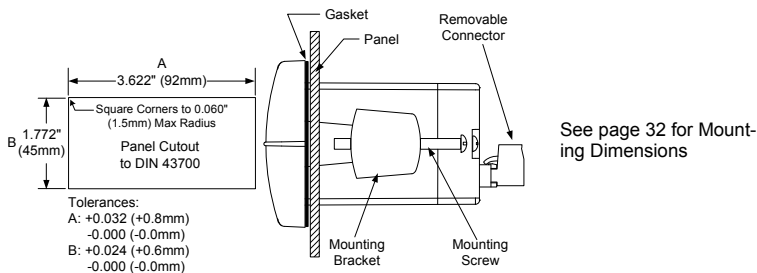

Figure 1. Panel Cutout and Mounting

Wiring Connections

Signal connections are made to a four-terminal removable connector. This section is only intended for the PD683.

PD688 installation must be performed in accordance with Control Drawing LIM688-2 in order to meet agency approval ratings.

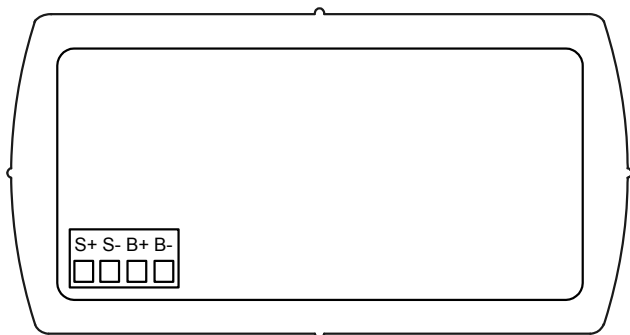
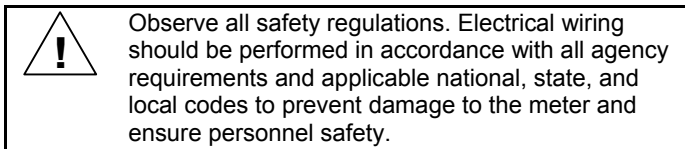

Figure 2. PD683 & PD688 Rear View

4-20 mA Input Connections

Input connections are made to a four-terminal connector labeled S+|S-|B+|B-. The loop-powered backlight is an optional configuration and requires a total maximum voltage drop of 5.7 V. The backlight is recommended for dim lighting conditions and is enabled when wired as shown in Figure 3. It may be bypassed if installed in bright lighting conditions to reduce the maximum voltage drop to 2.0 V as shown in Figure 4.

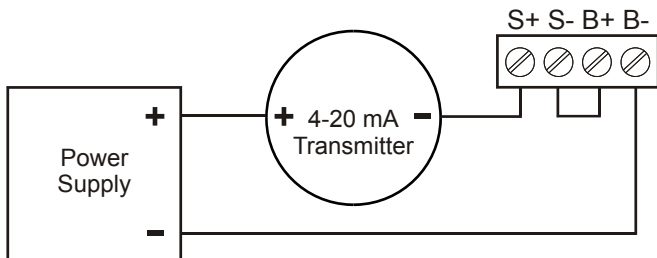

Figure 3. PD683 Input Connections with Backlight

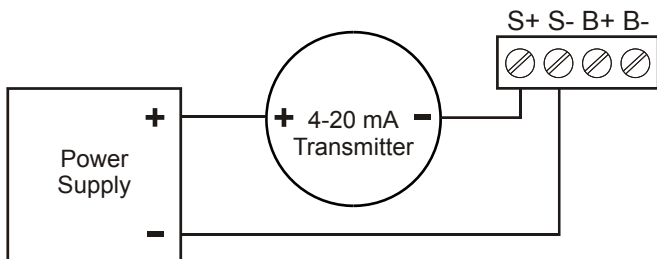

Figure 4. PD683 Input Connections without Backlight

SETUP AND PROGRAMMING

- There is **no need to recalibrate** the meter for milliamps when first received from the factory.
- The meter is **factory calibrated** for milliamps prior to shipment. The calibration equipment is certified to NIST standards.





Overview

There are no jumpers involved in the setup process of the meter. Setup and programming is done through the front panel buttons. After all connections have been completed and verified, apply power to the loop.

For
Quick User Interface Reference Guide
go to page 36

Front Panel Buttons & Status Indicators



Button Symbol	Description
	Menu
	Right arrow/Reset
	Up arrow/Max
	Enter/Ack

Symbol	Status
0%	Bargraph minimum
100%	Bargraph maximum
▲	Increasing trend
▼	Decreasing trend

- Press the **Menu** button to enter or exit the Programming Mode at any time.
- Press the **Right** arrow button to move to the next digit or decimal position during programming.
- Press the **Up** arrow button to scroll through the menus, decimal point, or to increment the value of a digit.
- Press the **Enter/Ack** button to access a menu or to accept a setting.
- Press and hold the **Menu** button for five seconds to access the *Advanced Features* of the meter.

Main Menu Display Functions & Messages

The meter displays various functions and messages during setup, programming, and operation. The following table shows the main menu functions and messages in the order they appear in the menu.

Display	Parameter	Action/Setting
SEtUP	Setup	Enter Setup menu
dEC.Pt	Decimal point	Set decimal point
unItS	Units	Enter the Units menu
PRoG	Program	Enter the Program menu
SCALE	Scale	Enter the Scale menu
CAL	Calibrate	Enter the Calibrate menu
inPt 1	Input 1	Calibrate input 1 signal or program input 1 value
d5PL 1	Display 1	Program display 1 value
inPt 2	Input 2	Calibrate input 2 signal or program input 2 value
d5PL 2	Display 2	Program display 2 value
Error	Error	Error, calibration not successful, check signal
GrAPh	Graph	Enter the Graph menu
PR55	Password	Enter the Password menu
unLoc	Unlocked	Program password to lock meter
Locd	Locked	Enter password to unlock meter
99999 -99999	Flashing display	Overrange condition Underrange condition

Main Menu

The main menu consists of the most commonly used functions: *Setup*, *Program*, and *Password*.

- Press **Menu** button to enter Programming Mode then press **Up** arrow button to scroll main menu.

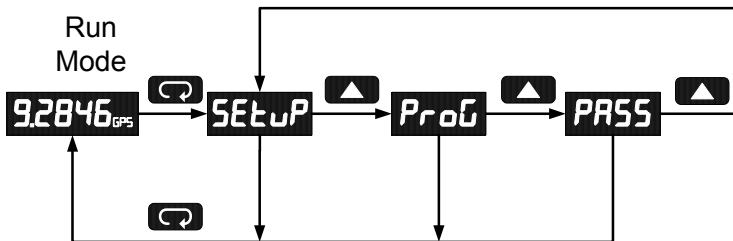

- Press **Menu**, at any time, to exit and return to Run Mode. Changes made to settings prior to pressing **Enter/Ack** are not saved.
- Changes to the settings are saved to memory only after pressing **Enter/Ack**.
- The display moves to the next menu every time a setting is accepted by pressing **Enter/Ack**.

Setting Numeric Values

The numeric values are set using the **Right** and **Up** arrow buttons. Press **Right** arrow to select next digit and **Up** arrow to increment digit. The digit being changed blinks.

Press the **Enter/Ack** button, at any time, to accept a setting or **Menu** button to exit without saving changes.

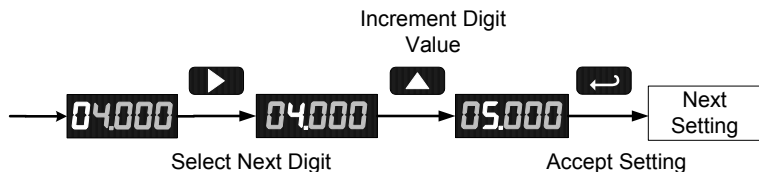

The decimal point is set using the **Right** or **Up** arrow button in the *Set-up-decimal point* menu.

Setting Up the Meter (SEtUP)

The *Setup* menu is used to select:

1. Decimal point position
2. Engineering units display

Press the **Enter/Ack** button to access any menu or press **Up** arrow button to scroll through choices. Press the **Menu** button to exit at any time.

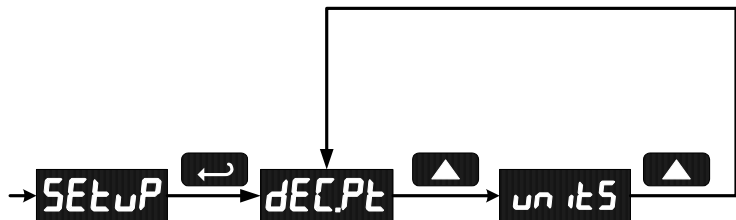

Setting the Decimal Point (dEC.Pt)

Decimal point may be set with up to four decimal places or with no decimal point at all.

Pressing the **Right** or **Up** arrow moves the decimal point one place to the right until no decimal point is displayed, then it moves to the left most position.

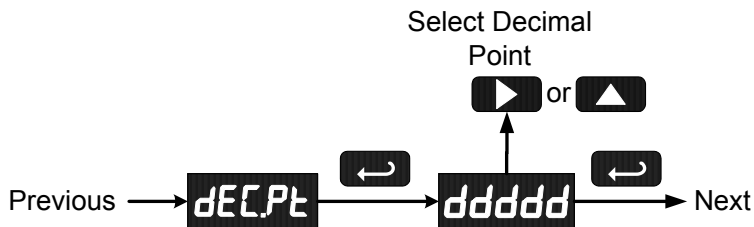

Setting the Units Display (unit 5)

The meter can be set to display a combination of three alphanumeric characters for engineering units or for identification (eg. PSI, G/S, LPM, TK3, L7). There is also a fourth alphanumeric character located above this row, which supports a degrees symbol and “x10” symbol (eg. °C, °F, x103, x106, x109).

Press **Right** arrow to select next unit and **Up** arrow to increment unit. The unit being changed blinks.

Press the **Enter/Ack** button, at any time, to accept a setting or **Menu** button to exit without saving changes.

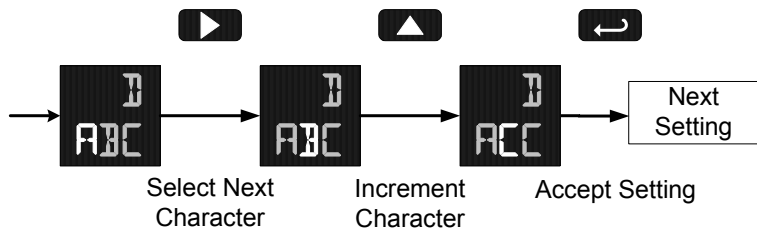

Programming the Meter (*Prog*)

It is **very important** to read the following information, before proceeding to program the meter:

- There is **no need to recalibrate** the meter for milliamps when first received from the factory.
- The meter is **factory calibrated** for milliamps prior to shipment. The calibration equipment is certified to NIST standards.
- Use the *Scale* menu to enter scale parameters without applying a live signal.
- Alternatively, use the *Calibrate* menu to apply a signal from a calibrator or a 4-20 mA transmitter to calibrate the meter.

The *Program* menu contains the *Calibrate* and the *Scale* menus.

Inputs may be calibrated or scaled to any display within the range of the meter.

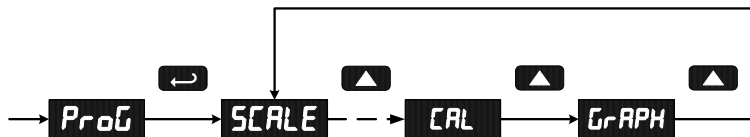

Additional parameters, not needed for most applications, are programmed with the *Advanced Features* menu, see *Advanced Features Menu*, page 24.

Error Message (*Error*)

An error message indicates that the calibration or scaling process was not successful.

After the error message is displayed, the meter reverts to input 1, allowing the appropriate input signals to be applied.

The error message might be caused by one of the following conditions:

1. Minimum input span requirements not maintained.
2. Input 1 signal inadvertently applied to calibrate input 2.

Minimum Input Span

The minimum input span is the minimum difference between input 1 and input 2 signals required to complete the calibration or scaling of the meter. The minimum span is 0.40 mA.

Scaling the Meter (*SCALE*)

The 4-20 mA input can be scaled to display the process in engineering units.

A signal source is not needed to scale the meter; simply program the inputs and corresponding display values.

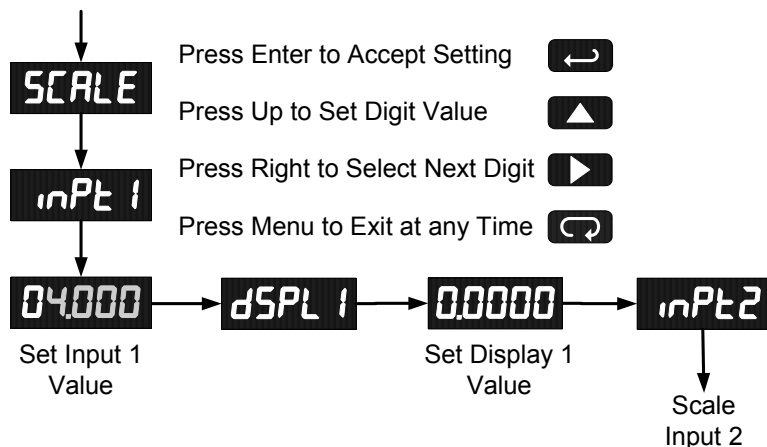

For instructions on how to program numeric values see *Setting Numeric Values*, page 15.

Calibrating the Meter (CAL)

To scale the meter without a signal source refer to *Scaling the Meter (sCalE)*, page 19.

The meter can be calibrated to display the process in engineering units by applying the appropriate input signal and following the calibration procedure.

The use of a calibrated signal source is strongly recommended.

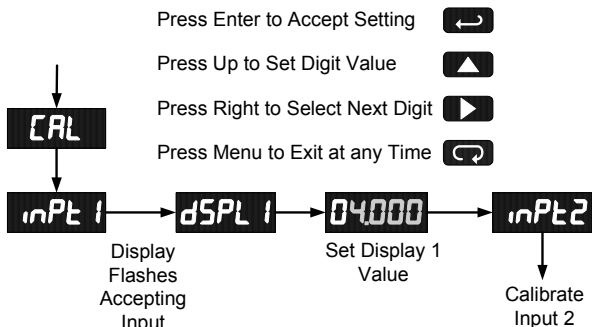

1. Press the **Up** arrow button to scroll to the *Calibration* menu (CAL) and press **Enter/Ack**.
2. The meter displays **inPt 1**. Apply a known signal and press **Enter/Ack**. Trend arrows are displayed while accepting the signal.
3. After the signal is accepted, the meter displays **d5PL 1**. Press **Enter/Ack**, enter a corresponding display value for the signal input, and press **Enter/Ack** to accept.
4. The meter displays **inPt 1**. Apply a known signal and press **Enter/Ack**. Trend arrows are displayed while accepting the signal.
5. After the signal is accepted, the meter displays **d5PL 2**. Press **Enter/Ack**, enter a corresponding display value for the signal input, and press **Enter/Ack** to accept.

Recalibrating the Internal Calibration Reference (iCAL)

The *Internal Calibration (iCAL)* menu, located in the *Advanced* features menu, is used to recalibrate the internal calibration reference. Recalibration is recommended at least every twelve months. Refer to *Internal Calibration (ICal)*, page 28 for instructions.

Setting Up the Bargraph (GRAPH)

The meter can be set to display a bargraph proportional to the percentage process reading within a user-defined span.

The span is determined by values entered for 0% and 100%.

If the 0% and 100% values are the same as the values that were entered for display 1 and display 2, respectively, from the scale or calibrate steps, then it is not necessary to modify them.

The bargraph may be disabled by selecting *OFF* from the bargraph menu.

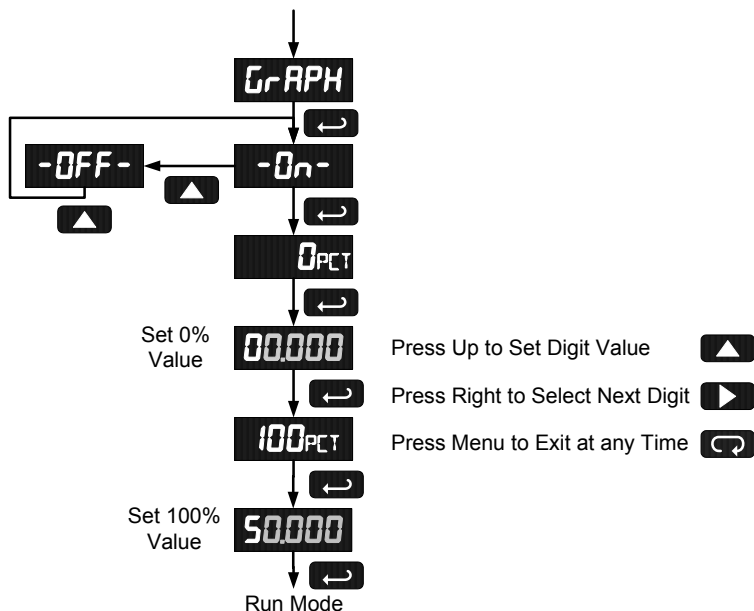

Setting Up the Password (PASS)

The *Password* menu is used to program a five-digit password to prevent unauthorized changes to the programmed parameter settings.

Locking the Meter

Enter the *Password* menu and program a five-digit password.

For instructions on how to program numeric values see *Setting Numeric Values*, page 15.

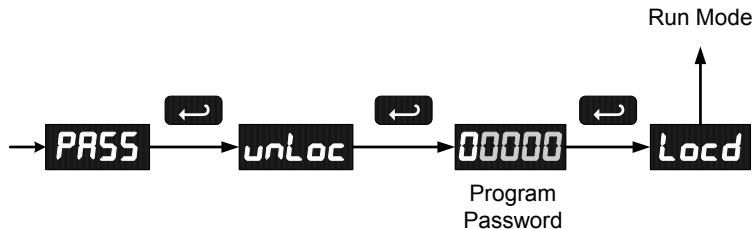

Record the password for future reference. If appropriate, it may be recorded in the space provided.

Model:	
Serial Number:	
Password:	— — — — —

Unlocking the Meter

If the meter is password protected, the correct password must be entered in order to make changes to the parameter settings.

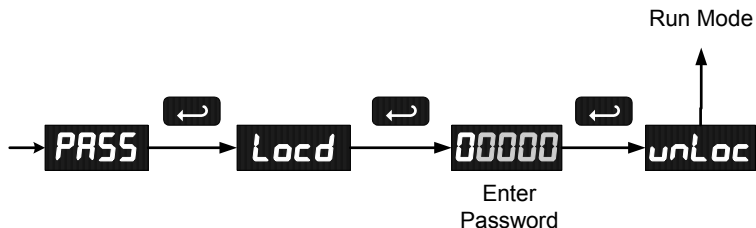

Entering the correct five-digit number sets the password to 00000, disabling the protection. The meter remains unlocked until a new password is programmed or the former password is re-programmed using the *Password* menu.

Changes to the programmed parameter settings are allowed only with the password set to 00000.

If the password entered is incorrect, the meter displays *Locd* (Locked) for about three seconds, then it returns to Run Mode. To try again, press **Enter/Ack** while the *Locked* message is displayed.

Forgot the Password?

The password may be disabled by the following procedure:

1. Note display reading prior to pressing the Menu button. Ignore decimal point and sign.
2. Access the *Password* menu, add 2 to the noted reading and enter that number as the password (e.g. display reading = -1.23, password = 00125).

Advanced Features Menu

To simplify the setup process, functions not needed for most applications are located in the *Advanced Features* menu.

Press and hold the **Menu** button for five **seconds** to access the *Advanced Features* of the meter.

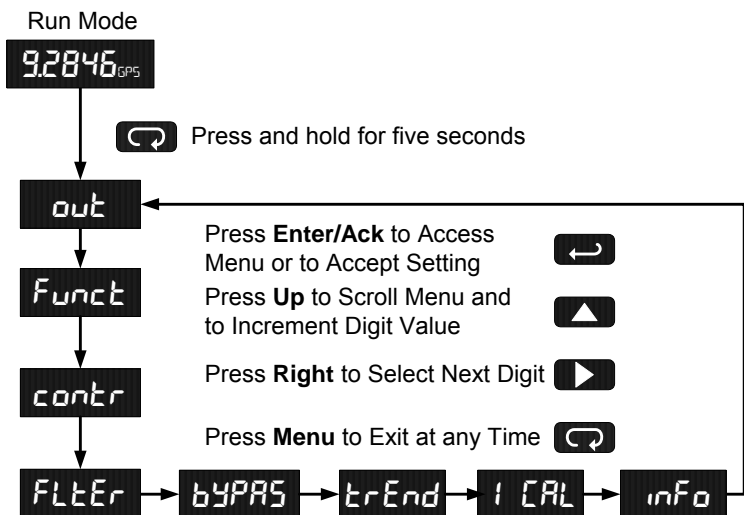

Advanced Features Menu & Display Messages

The following table shows the *Advanced* features menu functions and messages in the order they appear in the menu.

Display	Parameter	Action/Setting
<i>Funct</i>	<i>Function</i>	Enter Function menu
<i>LnERr</i>	<i>Linear</i>	Set linear scaling
<i>SqURr</i>	<i>Square Root</i>	Set square root extraction
<i>PrOUE</i>	<i>Programmable Exponent</i>	Set programmable exponent
<i>cUtOƒ</i>	<i>Low-Flow Cutoff</i>	Set low-flow cutoff
<i>conEr</i>	<i>Contrast</i>	Enter contrast adjustment menu
<i>FLtEr</i>	<i>Filter</i>	Set noise filter value
<i>bYPAS</i>	<i>Bypass</i>	Set filter bypass value
<i>tREnd</i>	<i>Trend Arrows</i>	Enable or disable trend arrows
-On-	<i>On</i>	Enable trend arrow display
-OFF-	<i>Off</i>	Disable trend arrow display
<i>iCAL</i>	<i>Initial calibration</i>	Enter initial calibration for process inputs
<i>Info</i>	<i>Meter information</i>	Show software number and version, or reset to defaults
<i>rESEt</i>	<i>Reset Defaults</i>	Restore factory default parameter settings

For instructions on how to program numeric values see *Setting Numeric Values*, page 15.

Math Functions (*LnERr*, *SqURr*, *ProGE*, *CutoF*)

The PD683 & PD688 provide a number of math functions to condition outputs from linear and non-linear transmitters.

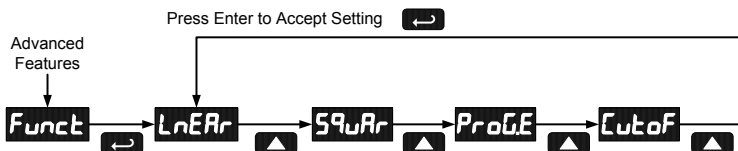

Linear (*LnERr*)

Meters are set up at the factory for linear function. The linear function provides a display that is linear with respect to the input signal.

Square Root (*SqURr*)

The square root function is used to linearize the signal from a differential pressure transmitter and display flow rate in engineering units.

Programmable Exponent (*ProGE*)

The programmable exponent function is used to linearize the level signal in applications using weirs and flumes and display flow rate in engineering units. Upon selecting programmable exponent (*ProGE*), the meter prompts entry of a 5-digit value between 0.5000 and 3.0000 as the exponent.

Low-Flow Cutoff (*CutoF*)

The low-flow cutoff feature allows the meter to be programmed so that the often-unsteady output from a differential pressure transmitter, at low flow rates, always displays zero on the meter. The cutoff value may be programmed from -99999 to 99999. Below the cutoff value, the meter will display zero. Selecting either square root or programmable exponent will set the cutoff value to 0. Program the cutoff value to -99999 to disable.

Contrast (CONTR)

LCD contrast is adjustable through the front panel buttons. Select **CONTR** and increase level using Up Arrow/Max button. Settings 1 through 9 will be displayed on the screen as **11111** to **99999**. Settings 1 through 4 are usually best when viewing from below the angle perpendicular to the display. Settings 5 through 9 are usually best when viewing straight on (meter is at eye level) or when viewing from above.

Noise Filter (FLTER)

Most applications do not require changing this parameter. It is intended to help attain a steady display with an unsteady (noisy) input signal.

The field selectable noise filter averages any minor or quick changes in the input signal and displays the reading with greater stability.

Increasing the filter value will help stabilize the display, however this will reduce the display response to changes on the input signal.

The filter level may be set anywhere from 1 to 199.

Noise Filter Bypass (BYPASS)

The meter can be programmed to filter small input changes, but allow larger input changes to be displayed immediately, by setting the bypass value accordingly.

If the input signal goes beyond the bypass value, it will be displayed immediately with no averaging done on it.

The noise filter bypass value may be set anywhere from 0.2 to 99.9. It corresponds to percentage of full scale.

Increasing the bypass value may slow down the display response to changes on the input signal.

Pressing the **Right Arrow/Reset** button will also bypass the filter and provide an instant update.

Internal Calibration (*iCAL*)

- There is **no need to recalibrate** the meter for milliamps when first received from the factory.
- The meter is **factory calibrated** for milliamps prior to shipment. The calibration equipment is certified to NIST standards.

The internal calibration allows the user to scale the meter without applying a signal. The use of a calibrated signal source is necessary to perform the internal calibration of the meter. Check calibration of the meter at least every 12 months.

Notes:

- The signal source must have a full-scale accuracy of 0.01% or better between 4 and 20 mA in order to maintain the specified accuracy of the PD688.
- Allow the meter to warm up for at least 15 minutes before performing the internal calibration procedure.

The *Internal calibration* menu is part of the *Advanced* features menu.

1. Press and hold the **Menu** button for five **seconds** to access the Advanced Features of the meter.
2. Press the **Up** arrow button to scroll to the *Internal calibration* menu (*iCAL*) and press **Enter/Ack**.
3. The meter displays 4.0000 mA. Apply a 4.000 mA signal and press **Enter/Ack**. The display shows both trend arrows for a moment while the meter is accepting the signal.
4. After the signal is accepted, the meter displays 8.0000 mA. Apply an 8.000 mA signal and press **Enter/Ack**. The display shows both trend arrows for a moment while the meter is accepting the signal.
5. Continue, as in the previous step, for the remaining signals: 12.000 mA, 16.000 mA, and 20.000 mA.

Error Message (Error)

An error message indicates that the calibration or scaling process was not successful. After the error message is displayed, the meter reverts to the previous signal prompt, allowing the appropriate input signal to be applied. The error message might be caused by inadvertently leaving the signal at the previous level.

Information Menu (*INF*)





The *Information* menu is located in the *Advanced* features menu, to access *Information* menu see *Advanced Features Menu*, page 24.

It shows software and version number. To determine the software version of a meter:

1. Go to the *Information* menu (*INF*) and press **Enter/Ack** button. The number shown is the software number.
2. Press **Enter/Ack** again to display the release version.

OPERATION

Front Panel Buttons Operation

Button Symbol	Description
	Press to enter or exit Programming Mode, view settings, or exit Max/Min readings
	Press to reset Max/Min readings Press to manually bypass filtering
	Press to display Max/Min readings alternately
	Press to display Max/Min reading indefinitely while displaying Max/Min Press ACK to acknowledge trend arrows

Maximum & Minimum Readings (MAX & MIN)

The maximum and minimum (peak & valley) readings reached by the process are stored in the meter since the last reset or power-up. The meter shows MIN or MAX to differentiate between run mode and max/min display.

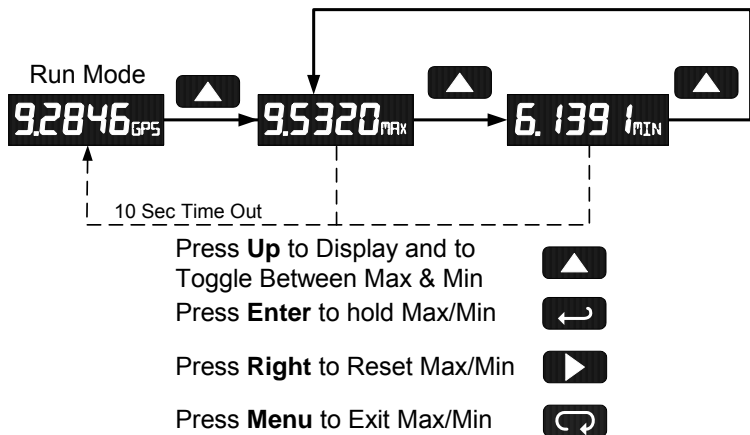

1. Press **Up** arrow/**Max** button to display maximum reading since the last reset/power-up.
2. Press **Up** arrow/**Max** again to display the minimum reading since the last reset/power-up.
3. Press **Enter/Ack** to hold Max/Min display reading, the meter will continue to track new Max/Min readings.
4. If **Enter/Ack** is not pressed, the Max/Min display reading will time out after ten seconds and the meter will return to display the actual reading.
5. Press **Right** arrow/**Reset** button to reset Max/Min while reading is being displayed. Max/Min display readings are reset to actual reading.

MOUNTING DIMENSIONS

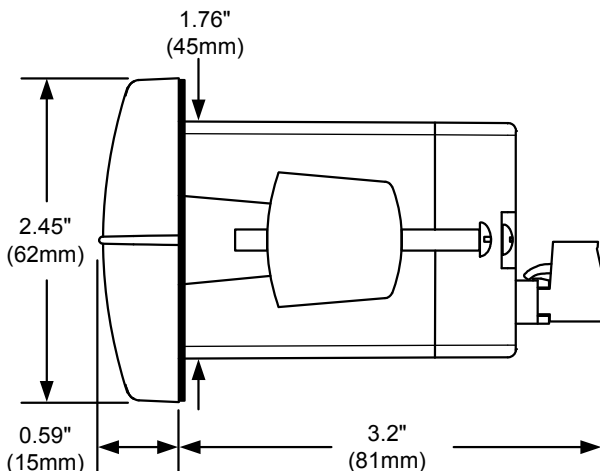

Figure 5. Meter Dimensions – Side View

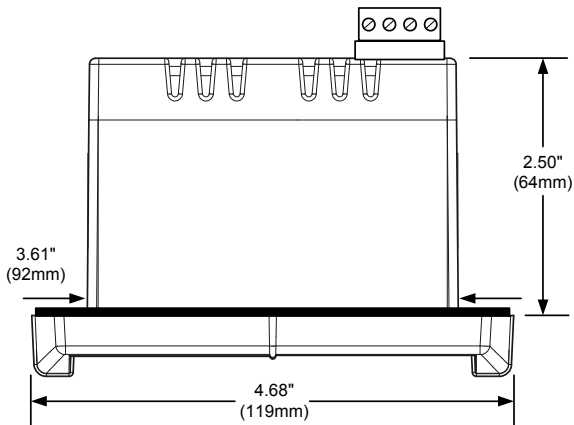

Figure 6. Case Dimensions – Top View

Reset Meter to Factory Defaults

When the parameters have been changed in a way that is difficult to determine what's happening, it might be better to start the setup process from the factory defaults.

Instructions to load factory defaults:

1. Enter the *Advanced* features menu. See *Advanced Features Menu*, page 24.
2. Press **Up** arrow until *inFo* is shown.
3. Press and hold **Right** arrow/Reset for five seconds, press **Enter/Ack** when display flashes *rESEt*.
Note: If **Enter/Ack** is not pressed within three seconds, display returns to *Information* menu.
4. The meter goes through an initialization sequence (same as on power-up), and loads the factory default settings.

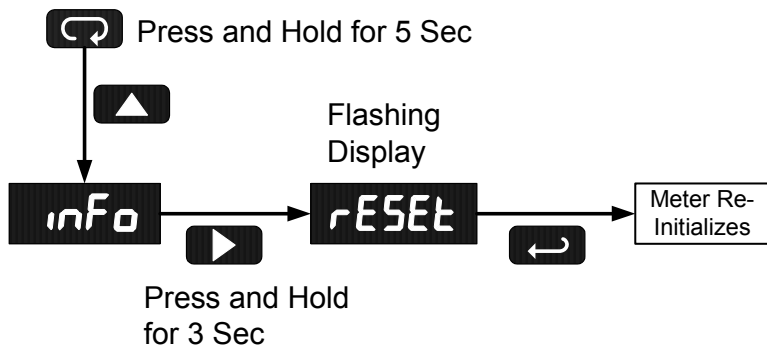

Factory Defaults & User Settings

The following table shows the factory setting for most of the programmable parameters on the meter. Next to the factory setting, the user may record the new setting for the particular application.

Model: _____ S/N: _____ Date: _____

Parameter	Display	Default Setting	User Setting
<i>Programming</i>	PrOG	Scale	
<i>Input 1</i>	inPt 1	4.000 mA	
<i>Display 1</i>	dSPL 1	4.000	
<i>Input 2</i>	inPt2	20.00 mA	
<i>Display 2</i>	dSPL2	20.000	
<i>Decimal point</i>	dddd	3 places	
<i>Bargraph</i>	GrAPH	On (enabled)	
<i>Bargraph 0%</i>	0 PCT	4.000	
<i>Bargraph 100%</i>	100 PCT	20.000	
<i>Password</i>	PASS	00000 (unlocked)	
Advanced Features			
<i>Function</i>	Funct	Linear	
<i>Contrast</i>	contr	5 (55555)	
<i>Cutoff</i>	CutoF	-99999 (disabled)	
<i>Filter</i>	FLtEr	1	
<i>Bypass</i>	bYPAS	0.2	
<i>Trend Arrows</i>	trEnd	On (enabled)	

TROUBLESHOOTING

The rugged design and the user-friendly interface of the meter should make it unusual for the installer or operator to refer to this section of the manual.

If the meter is not working as expected, refer to the recommendations below.

Troubleshooting Tips

Symptom	Check/Action
No display or faint display	<ol style="list-style-type: none"> 1. Check connections. 2. Increase contrast setting in <i>Advanced</i> menu. 3. Perform hard reset by temporarily shorting S+ and S- terminals for a few seconds.
Rate display unsteady	Increase filter setting in <i>Advanced</i> menu.
Not able to change setup or programming, <i>Lcd</i> is displayed	Meter is locked, enter correct five-digit password to unlock.
Meter displays error message during calibration (<i>Error</i>)	Check: <ol style="list-style-type: none"> 1. Signal connections 2. Minimum input span requirements
Meter displays <ul style="list-style-type: none"> • 99999 • -99999 	Check: <ol style="list-style-type: none"> 1. Input signal within range. 2. When using square root or programmable exponent, cutoff must be zero or greater.
Display stuck showing a number and <i>MAX</i> or <i>MIN</i>	Press Menu to exit Max/Min display readings.
Display response is too slow	Check filter and bypass values to see if they can be lowered.
If the display locks up or the meter does not respond at all	Perform hard reset by temporarily shorting S+ and S- terminals for a few seconds and then removing short.
Display shows blurry, hard-to-read digits in below freezing temperatures (less than -18°C or 0°F).	Increase the filter setting to 10 or greater and the bypass setting to 50 or greater. This will slow the display response rate, but digits will be steady and appear more clearly.
Other symptoms not described above	Call Technical Support for assistance.

QUICK USER INTERFACE REFERENCE GUIDE

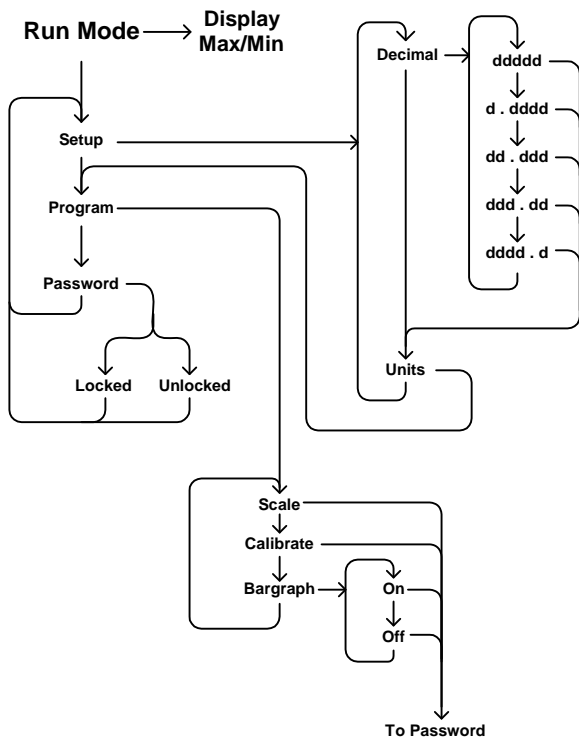

Pushbutton	Function
Menu	Go to Programming Mode or leave Programming, Advanced Features, and Max/Min Modes.
Right Arrow	Move to next digit or decimal point position. Reset Total.
Up Arrow	Move to next selection or increment digit. Go to Max/Min Mode.
Enter/Ack	Accept selection/value and move to next selection. Toggle Rate/Total.
	Hold to Acknowledge Alarm.

Menu held for 5 seconds enters Advanced Features

Max/Min Mode

While in Run Mode, pressing **Up Arrow** will initiate Max/Min Mode. **Up Arrow** toggles between Max & Min displays, and **Right Arrow** resets the Max/Min to the current value. Press **Menu** or wait 10 seconds to return to Run Mode. Pressing **Enter/Ack** will disable the 10 second timeout and continuously display Max or Min.

Press & hold **Menu** for 5 seconds to access Advanced Features Menu

When a password is enabled, parameter settings are locked, but scale settings can be displayed by selecting the program menu.

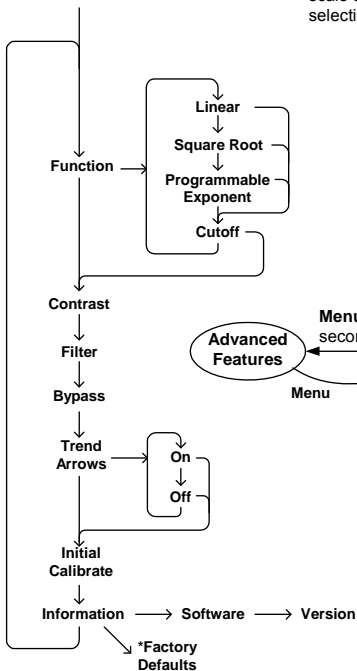

Operational Modes

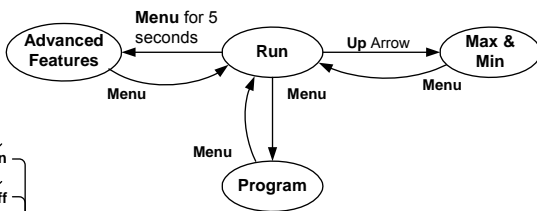

*Access by holding **Right/Reset** for 3 seconds

**PRECISION
DIGITAL** **EC DECLARATION OF CONFORMITY**

Issued in accordance with ATEX Directive 94/9/EC

Manufacturer: Precision Digital Corporation
89 October Hill Rd Ste 5
Holliston, MA 01746 USA

Device: PD688 Series Loop Powered Panel Meter

Notified Body: FM Approvals Ltd., notified body no. 1725
1 Windsor Dials, Windsor, Berkshire, UK. SL4 1RS

EC Type Examination Certificate: FM08ATEX0058X

Quality Assurance Notification No.: SIRA 10 ATEX M462

Compliance with Standards:

EN 60079-0:2006
EN 60079-11:2007
EN 60079-26:2007
EN 61326:2006

IEC 61010-1:2010 & EN 61010-1:2010, including Group and National Differences as they apply for AU, CA, US and KR

Product Markings:

 II 1 G Ex ia IIC T4
Ta = -40°C to +65°C

The standards EN 60079-0:2006 and EN 60079-11:2007 are no longer harmonized. The requirements of these standards have been checked against the harmonized standards EN 60079-0:2012 and EN 60079-11:2012 and there were no major technical changes affecting the latest technical knowledge for the products listed above.

Community Directives:

94/9/EC ATEX Directive
2004/108/EC EMC Directive



Name: Jeffrey Peters
Company: Precision Digital Corporation
Title: President
Date: 08/01/2014

NOTES

How to Contact Precision Digital

- For Technical Support:
Call: (800) 610-5239 or (508) 655-7300
Fax: (508) 655-8990
Email: support@predig.com
- Distributor:
Clark Solutions
10 Brent Drive
Hudson, MA 01749
Tel: 800-253-2497
- For the latest version of this manual please visit:
www.predig.com

